

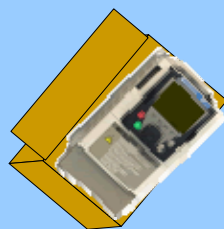

MOTORTRONICS MT Series

Out of the box Startup



OVERVIEW

This document will enable the user to quickly get the motor turning with a minimum amount of external connections using the keypad. It will also provide familiarity with keypad navigation allowing selection and the changing of additional parameters. It must be realized that it is not a substitute for the MT Series Manual (Doc # MT12280601MN) and the user is urged to review this document before proceeding.

Steps 1 through 4 will allow the user to operate the motor in a simple mode. The reverse side of this document shows other methods of control as well as motor tuning and other parameter changes such as acceleration and deceleration times.

MOTORTRONICS
Solid State AC Motor Controls

1600 Sunshine Drive
Clearwater, FL 33765
Phone: 727-573-1819
Fax: 727-573-1803
www.motortronics.com

1 Connect Motor and Line power

Secure the Inverter in a suitable location

! DANGER
Do not apply power until all connections are correct and secure, and all protective covers are in place.



Refer to the MT Series Manual (Doc # MT12280601MN) for instructions on cover removal and Motor and Power electrical connections

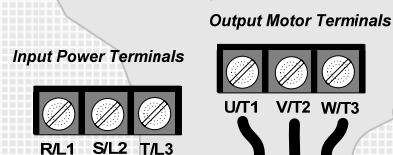

After all connections are secure and protective covers replaced the inverter may now be powered - up

Go To Step 2

2 Enter Motor Data

On power-up initialization screens will appear momentarily

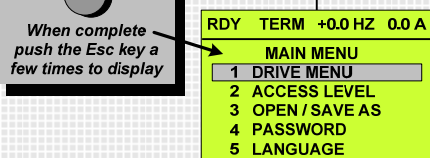
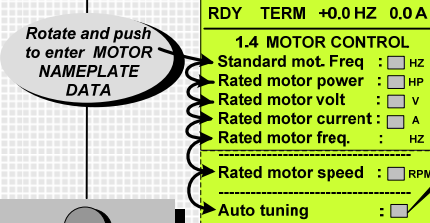
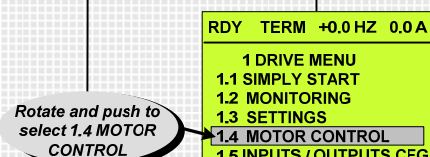
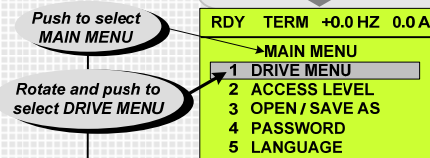
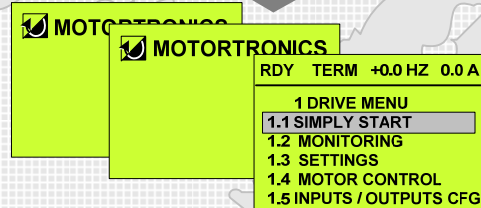

The Escape key can be used to return a previous selection

Auto tuning is recommended See reverse side for procedure

Go To Step 3

3 Set Keypad (HMI) Control

Keypad (HMI) control is easiest as all functions are performed with the keypad

NOTE: Other methods of control are described on page 2

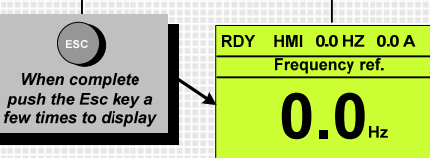
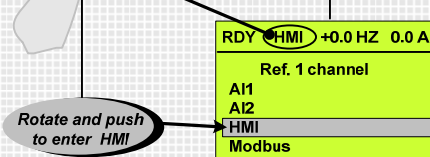
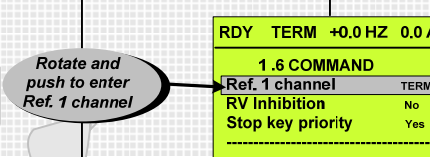
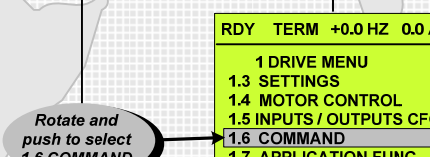
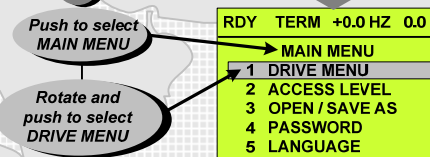
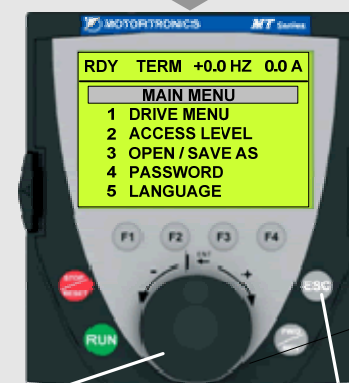

The Escape key can be used to return a previous selection

When complete push the Esc key a few times to display

Go To Step 4

4 Run the motor

In this step the motor will initially be run at 5 Hz and the motor checked for proper rotation

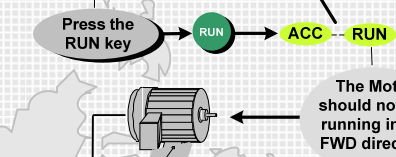
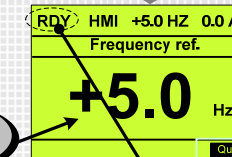
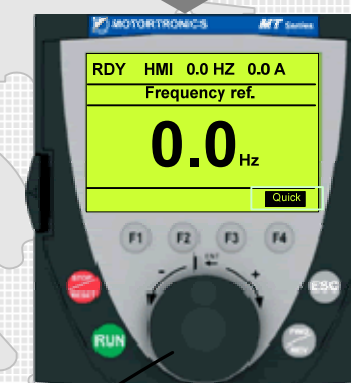

If the motor is running in the reverse (REV.) direction, it may be reversed either by changing a parameter or physically swapping two of the output motor leads.

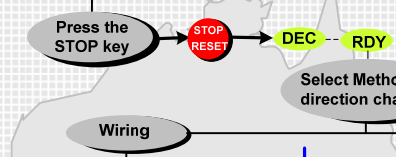

! DANGER
Disconnect power from the inverter and wait 15 Min. before making any wiring changes

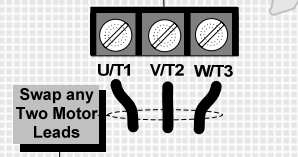

When complete power-up the inverter and repeat STEP 4

Follow the menu selection in STEP 2 and select Output Phase Rotation

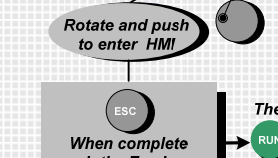
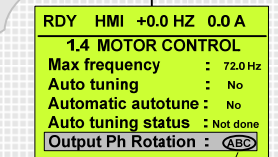

When complete push the Esc key a few times to return to main menu

Then RUN



Default Parameters

The MT Series is factory set for the most common applications. The following is a list of the parameters and values. Please refer to the MT Series manual for further explanation.

Macro-configuration: Start/Stop

- Motor frequency: 60 Hz
- Constant torque application with sensorless flux vector control
- Normal stop mode on deceleration ramp
- Stop mode in the event of a fault: freewheel
- Linear, acceleration and deceleration ramps : 3 seconds
- Low speed: 0 Hz
- High speed: 60 Hz
- Motor thermal current = rated drive current
- Standstill injection braking current = 0.7 x rated drive current, for 0.5 seconds
- No automatic starts after a fault
- Switching frequency 2.5 kHz or 4 kHz depending on drive rating.
- Logic inputs:
 - LI1: Forward, LI2: reverse (2 operating directions), 2-wire control on transition
 - LI3, LI4, LI5, LI6: inactive (not assigned)
- Analog inputs:
 - AI1: Speed reference 0 +/-10 V
 - AI2: 0-20 mA inactive (not assigned)
- Relay R1: The contact opens in the event of a fault (or drive off)
- Relay R2: inactive (not assigned)
- Analog output AO1: 0-20 mA inactive (not assigned)

Option card factory settings

The option card inputs/outputs are not factory-set.

MOTORTRONICS

Solid State AC Motor Controls

1600 Sunshine Drive
Clearwater, FL 33765
Phone: 727-573-1819
Fax: 727-573-1803
www.motortronics.com

Motor Auto Tuning

Although motor tuning is not required, it is recommended for optimum system performance. The following procedure can be done as part of STEP 2 on the reverse side.

⚠ The motor does not have to be disconnected from the load when performing the Motor Auto Tuning function.

Ensure that the motor data as per STEP 2 has been entered

Follow STEP 2 to get to the following screen

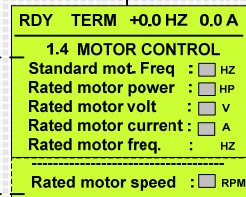

Rotate and push to enter auto tuning

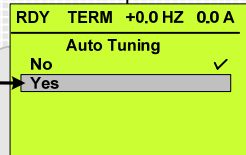

Rotate and push to enter Yes

After Auto Tuning is complete the display will go back to the MOTOR CONTROL screen and show: Auto Tuning: Done

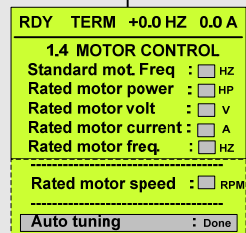

When complete push the Esc key a few times to display MAIN MENU

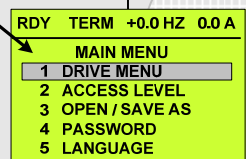

➡ Go To Step 3

(On opposite side)

Other Methods Of Control

TERMINAL

Terminal control, is the factory default (out of the box) setting, and initially does not require the user to set any parameters. If another method of control has been previous selected, then follow STEP 3 on the reverse side and select AI1 in the Ref. 1 channel screen.

⚠ DANGER
Do not apply power until all connections are correct and secure, and all protective covers are in place.

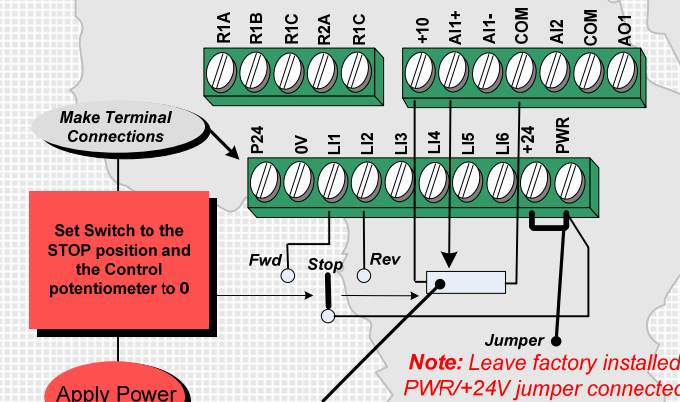

Note: Leave factory installed PWR/+24V jumper connected

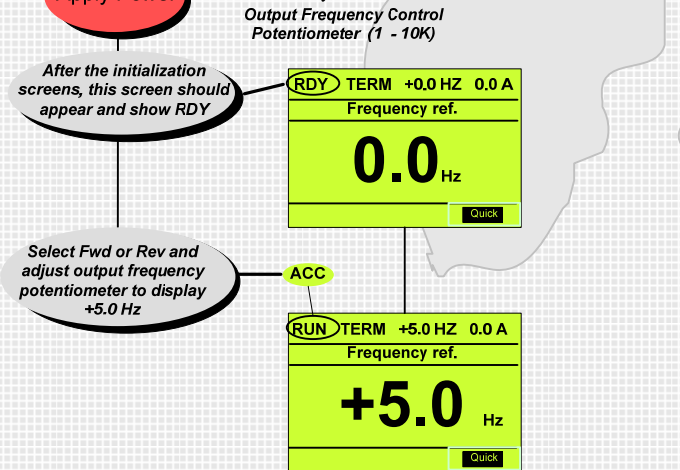

NOTE: The scheme shown is an example. Other methods for reference control such as 4-20 mA can be used. Please refer to the MT series Manual for more information.

SERIAL

One or more (networked) inverters may be controlled by Modbus RTU protocol. Depending on the application, the serial cable may be connected to the keypad (HMI) port (RJ45) or the port provided on the terminal module.

NOTE: It is beyond the scope of this document to provide a detailed description of serial control and the user is referred to the Modbus Manual for further instruction.

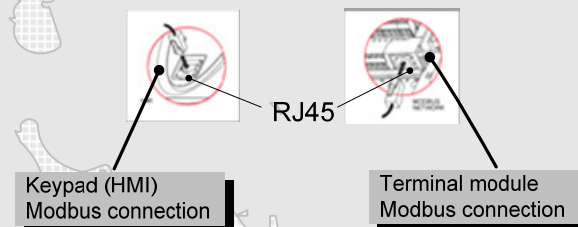

To select Modbus control follow STEP 3 on the reverse side and select Modbus in the Ref. 1 channel screen.

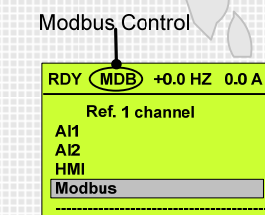

When complete push the Esc key a few times to return to the display screen

The inverter is now ready to communicate

Setting Acceleration and Deceleration Time

To set the acceleration and / or the deceleration time proceed as follows.

